

ELECTRO-PROPORTIONAL VALVES—DIRECTIONAL CONTROL

SP08-57D Spool, 5-Way, 3-Position . . .

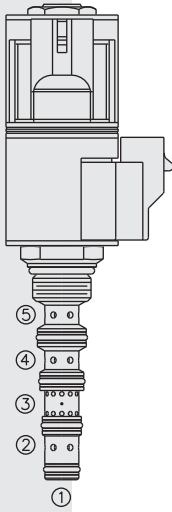

DESCRIPTION

A solenoid-operated, five-way, three-position, proportional, screw-in hydraulic cartridge valve with integral load-sense port.

OPERATION

When de-energized, the **SP08-57D** blocks flow at ⑤ while allowing flow from both ② and ④ to ③. When coil #1 is energized, flow is allowed from ⑤ to ②, and from ④ to ③. When coil #2 is energized, flow is allowed from ⑤ to ④, and from ② to ③. Load sense is connected to port ⑤ when the spool is in shifted positions.

Note: If low voltage is expected on the machine, 12 or 24 volt systems will require the use of 10 volt or 20 volt coils respectively. See “SP Valves and Coil Operating Parameters,” page 2.002.1.

FEATURES

- Continuous-duty rated solenoid.
- Hardened precision spool and cage for long life.
- Optional coil voltages and terminations
- Cartridges are voltage interchangeable.
- Compact size; Manual override options.
- Optional waterproof E-Coils rated up to IP69K.

SYMBOL

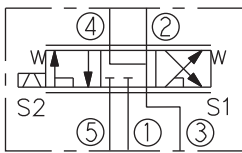

RATINGS

Operating Pressure: 241 bar (3500 psi) with standard Buna N seals

Flow: 9.5 lpm (2.5 gpm); see performance charts

Internal Leakage: 164 cc/minute (10 cu. in./minute) max. at 207 bar (3000 psi)

Temperature: -40 to 120°C with standard Buna seals

Coil Duty Rating: Continuous from 85% to 115% of nominal voltage

Initial Coil Current Draw at 20° C: Standard Coil: 1.2 amps at 12 VDC; 0.13 amps at 115 VAC (full wave rectified).

E-Coil: 1.4 amps at 12 VDC; 0.7 amps at 24 VDC

Minimum Pull-in Voltage: 85% of nominal at 207 bar (3000 psi)

Filtration: See page 9.010.1

Fluids: Mineral-based or synthetics with lubricating properties at viscosities of 7.4 to 420 cSt (50 to 2000 sus); See Temperature and Oil Viscosity, page 9.060.1

Installation: No restrictions; See page 9.020.1

Cavity: VC08-5; See page 9.108.1; **Cavity Tool:** CT08-5XX; See page 8.600.1

Seal Kit: SK08-5X-MMM; See page 8.650.1

Coil Nut: Part No. 7004400; **Coil Spacer:** Part No. 4534720

PERFORMANCE (Cartridge Only)

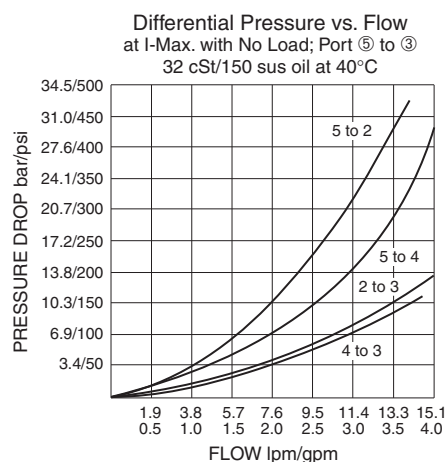
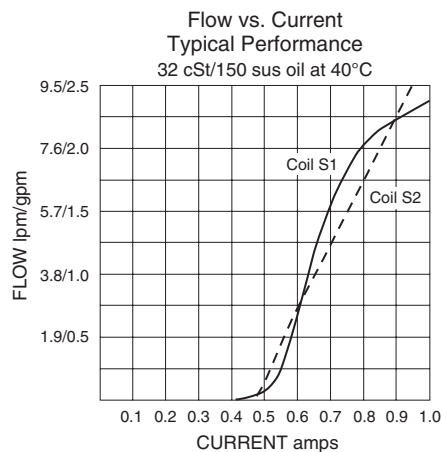

Performance information continued on following page.

for Load Sense Applications

SP08-57D

PERFORMANCE (Continued)

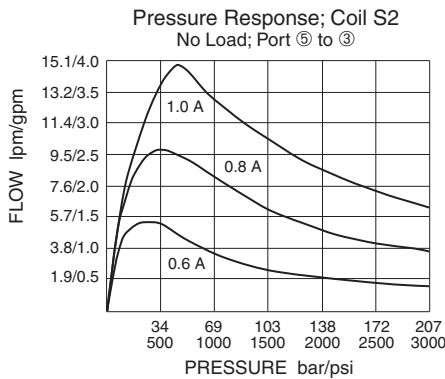
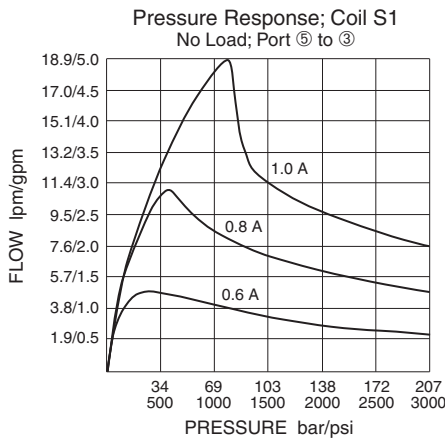

Recommended Electronic Controllers:
See page 2.001.1 or our Electronics catalog.

DIMENSIONS

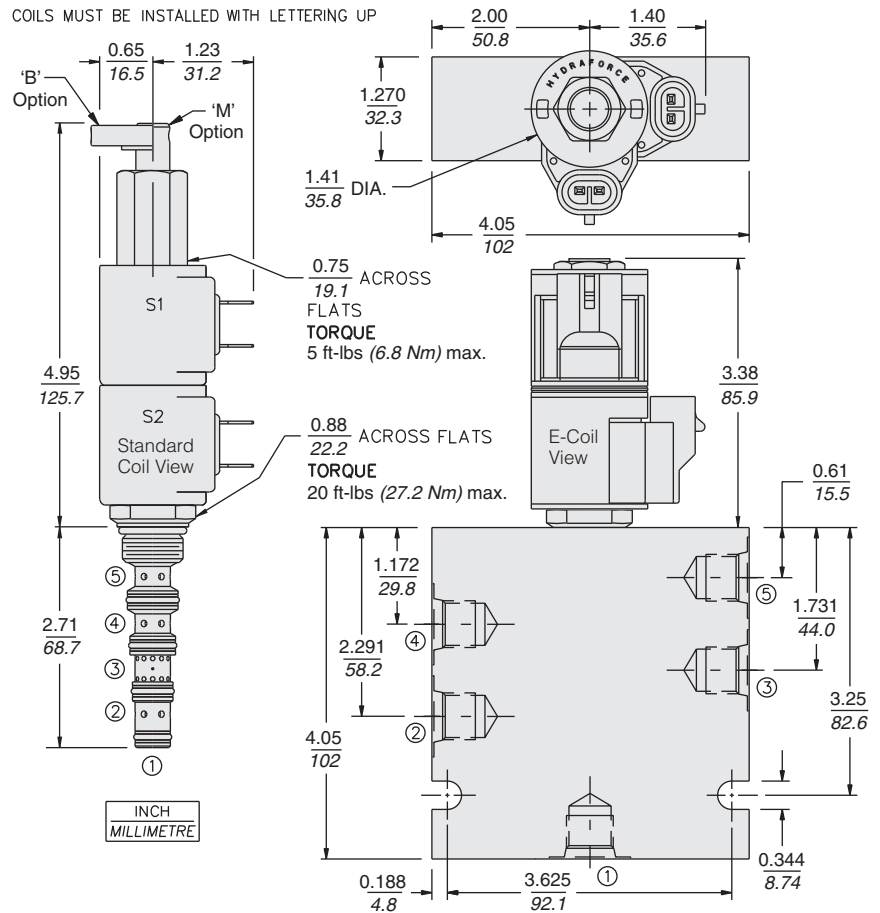

MATERIALS

Cartridge: Weight: 0.15 kg. (0.34 lbs.); Steel with hardened work surfaces. Zinc-plated exposed surfaces; Buna N O-rings and back-ups standard.

Standard Ported Body: Weight: 0.41 kg. (0.85 lbs.); Anodized high-strength 6061 T6 aluminum alloy, rated to 207 bar (3000 psi); Ductile iron bodies available; dimensions may differ. See page 8.008.1.

Standard Coil: Weight each: 0.11 kg. (0.25 lbs.); Unitized thermoplastic encapsulated, Class H high temperature magnetwire. See page 3.200.1

E-Coil: Weight: 0.14 kg. (0.3 lbs.); Perfect wound, fully encapsulated with rugged external metal shell; Rated up to IP69K with integral connectors. See page 3.400.1 for all E-Coil retrofit applications.

TO ORDER

SV08-57D

